



## Short Specification:

The Phoenix LED Frosted High Bays and Low Bays are designed beautifully around the LEDs which it houses. They're a truly unique lighting experience. Their sleek design automatically enhances the atmosphere in which they are used and their superior heat management will yield exceptional lighting for years to come. Contact your Louvers representative today to make the Phoenix LED High Bay or the Phoenix LED Low Bay a brilliant and modern solution to your lighting needs.



Phoenix 74W, 102W & 145W



Phoenix 230W

MODEL	DESCRIPTION	WATTS Model (Actual)	LUMENS	VOLTS
PHX22-74-4K	Phoenix 74W, 4K LED L.B.	74 (73.15)	9,613	120-277
PHX22-74-5K	Phoenix 74W, 5K LED L.B.	74 (73.15)	9,859	120-277
PHX22-102-4K	Phoenix 102W, 4K LED L.B.	102 (99.81)	12,787	120-277
PHX22-102-5K	Phoenix 102W, 5K LED L.B.	102 (99.81)	12,959	120-277
PHX22-145-4K	Phoenix 145W, 4K LED H.B.	145 (144.3)	17,848.6	120-277
PHX22-145-5K	Phoenix 145W, 5K LED H.B.	145 (146)	18,332.53	120-277
PHX22-230-4K	Phoenix 230W, 4K LED H.B.	230 (231.92)	28,333.15	120-277
PHX22-230-5K	Phoenix 230W, 5K LED H.B.	230 (234.16)	28,812.29	120-277

More CCT options are available. See ordering chart for full list.  
All models are DLC listed. For a complete list of DLC listed fixtures, visit [www.designlights.org/QPL](http://www.designlights.org/QPL)



BEFORE: Pre-Existing LED Lighting



AFTER: PHX22-145 Installed

## Application:

- Airports
- Auditoriums
- Convention Centers
- Factories
- Gymnasiums
- Ice Arenas
- Indoor/ Outdoor Lighting
- Industrial Spaces
- Malls
- Pools/ Pool Areas
- Retail Stores
- Storage Areas
- Warehouses

## Features:

- DLC listed
- NSF rated
- UL listed
- RoHS compliant
- FCC compliant
- Frosted polycarbonate diffuser lens to reduce glare
- Instant on to full brightness
- Energy efficient
- PHX22-145 replaces 400W MH, HPS or 6T5HO
- PHX22-230 replaces 750W-1000W MH, HPS
- Wide light distribution
- Lightweight for easy installation
- Lower maintenance costs
- Dimensions: 21.6" x 21.6" x 5.2"
- 120-277V or 347-480V (347-480V is only available for 145W 4K and 5K and 230W 5K models.)
- 2,700K to 5,700K color temperatures
- CRI: >80
- IP65 rated for wet locations
- Operating temp: -40 °C to +60 °C (-40 °F to +140 °F)
- 0 to 10V dimming capability
- L70 greater than 100,000 hours
- 7 year warranty



# PHOENIX

## LED Frosted High Bay / Low Bay

### Dimensions:

PHX22-74, PHX22-102, PHX22-145

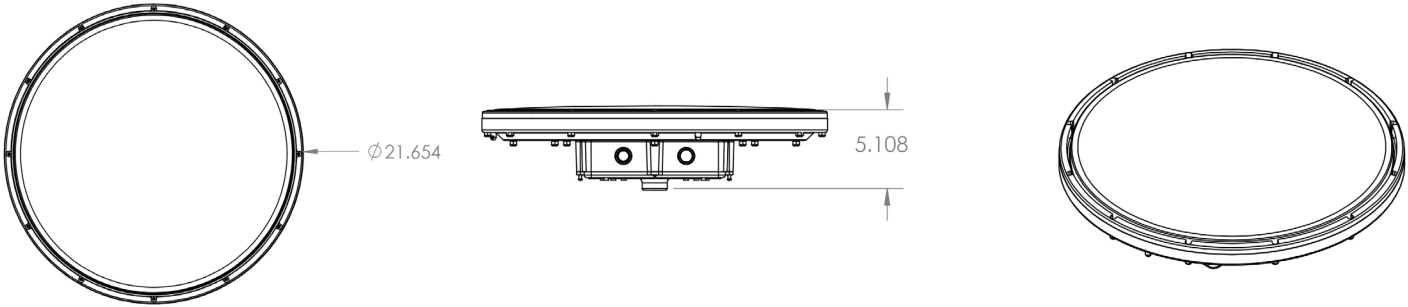

PHX22-230

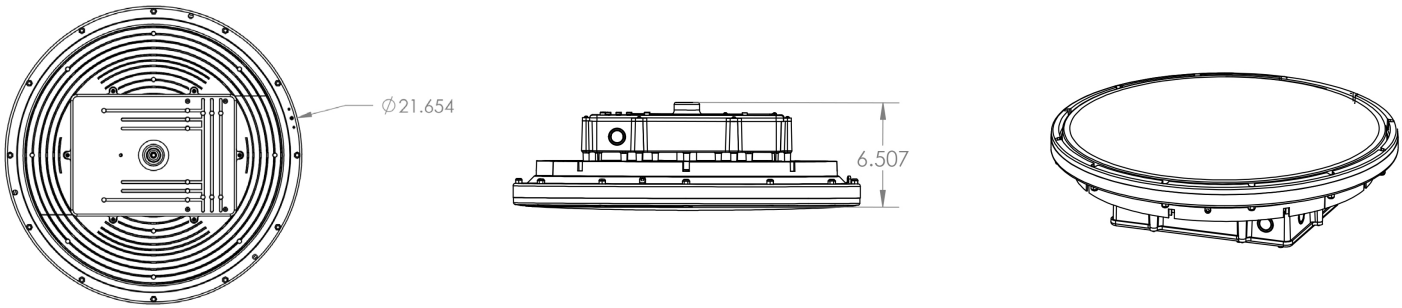

### 3 Point 5' Aircraft Cable Hanging Kit: LI-GL-PHX-60

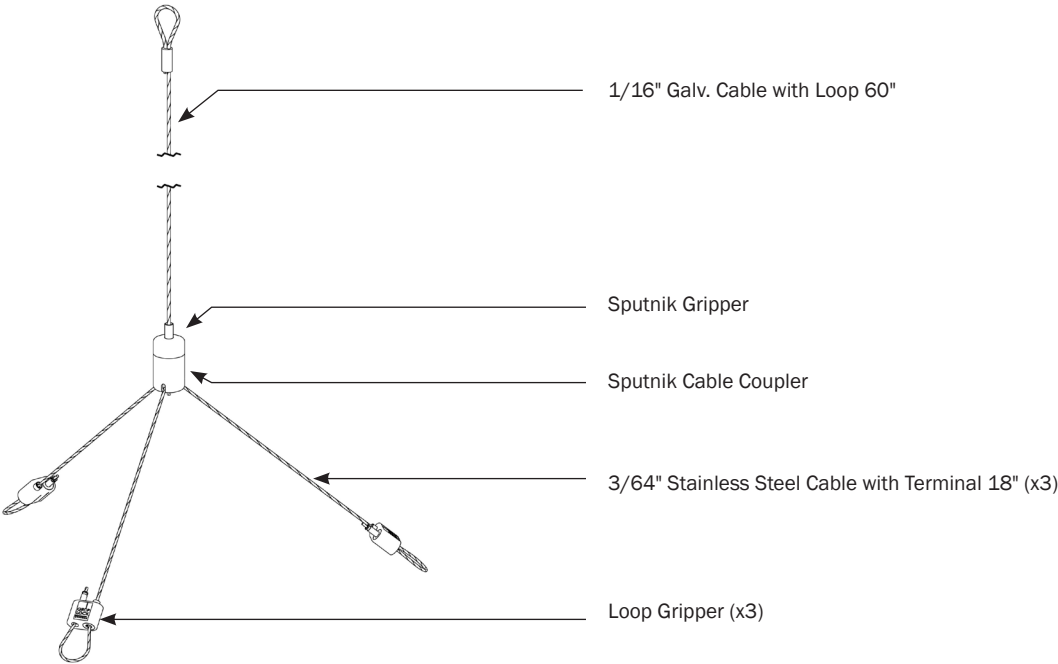

**Photometrics:**

**PHX22-145 at 5,000K**

PHX22-145-5K-U  
Light Distribution Curve [Unit: CD]

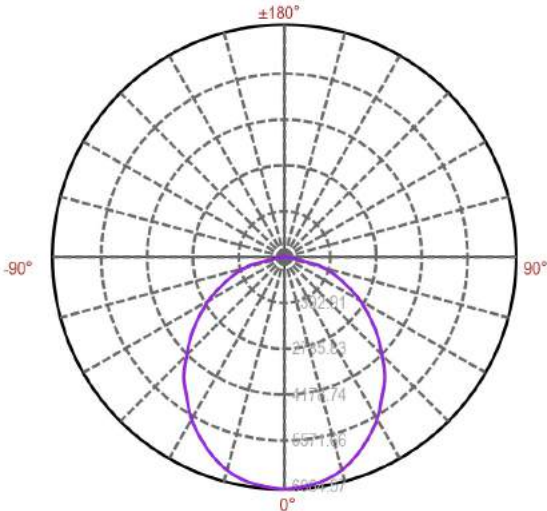

PHX22-145-5K-U  
Lux Distance Curve

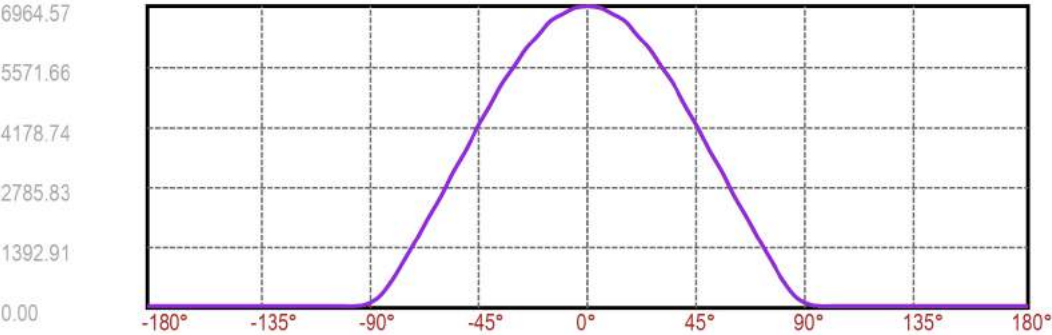
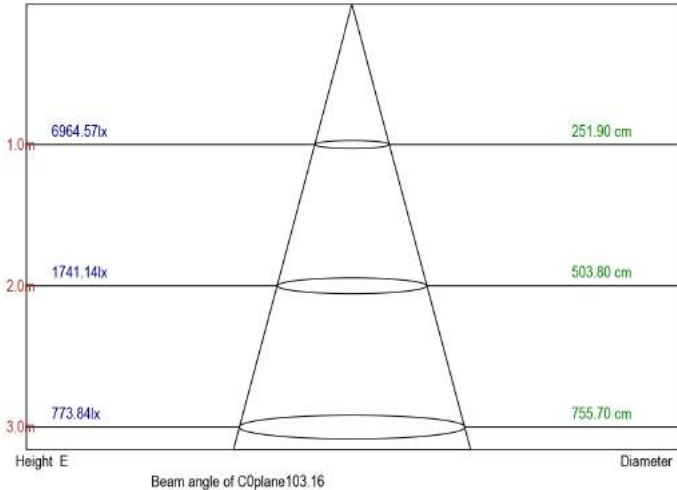

- C0(Max): —————
- C0/C180: —————
- C90/C270: —————

Equipment: LC-I-902 GMS-2000  
Temperature(°C): 25.0

Date: 2015-05-06  
Humidity(%): 65.0%

Operator: HJY  
Distance(m): 18.70

**Photometrics:**

**PHX22-230 at 5,000K**

PHX22-230-5K-U  
Light Distribution Curve [Unit: CD]

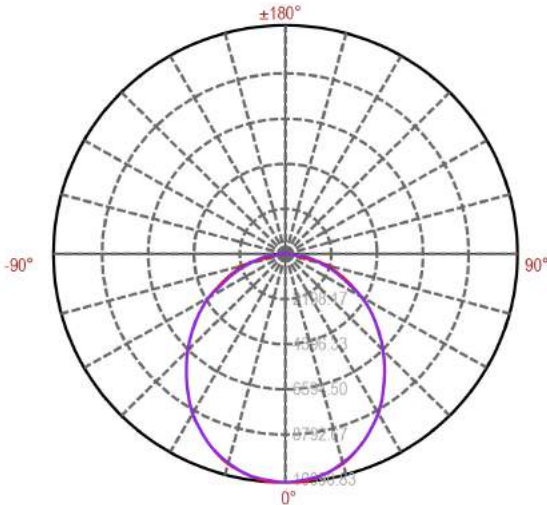

PHX22-230-5K-U  
Lux Distance Curve

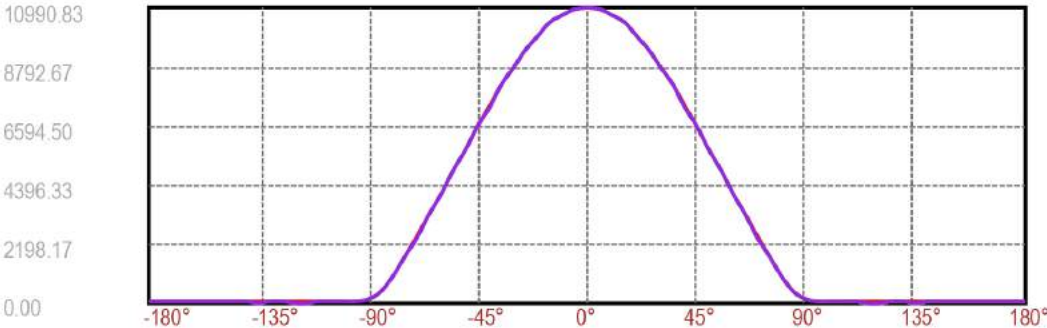
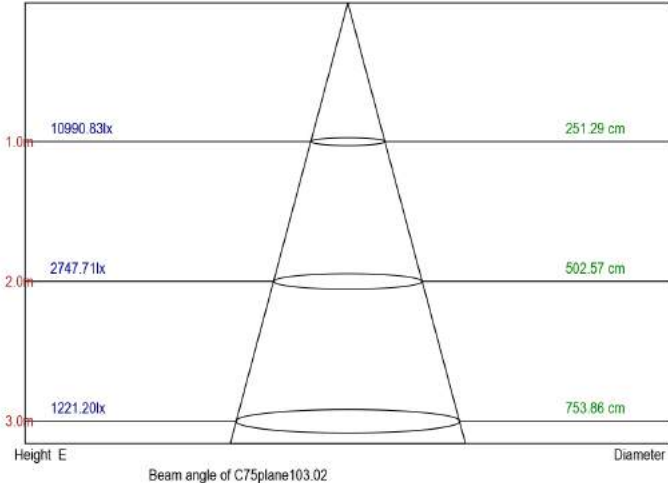

- C75(Max): —————
- C0/C180: —————
- C90/C270: —————

Equipment: LC-I-902 GMS-2000  
Temperature(°C): 25.0

Date: 2015-06-11  
Humidity(%): 65.0%

Operator: Liangzp  
Distance(m): 29.89

### Ordering Information:

PRODUCT SERIES Watts (Lumens; CCT)	VOLTAGE	LENS TYPE	FINISH	DIMMING	MOUNT	CORD & PLUG	OPTIONS
PHX22-74-27K - 74W (8646.9 Lm; 2,700K)	U - 120-277V	FPC	C - Custom	D - (0 to 10V) ^^	H - Hook Mount	15B	[None]
PHX22-74-3K - 74W (9366.8 Lm; 3,000K)	H - 347-480V ^		W - White		P - Pendant*	15W	BLD
PHX22-74-35K - 74W (9490 Lm; 3,500K)						65B	OCC
PHX22-74-4K - 74W (9613 Lm; 4,000K)						65W	PHO
PHX22-74-45K - 74W (9736 Lm; 4,500K)						1L5B	
PHX22-74-5K - 74W (9859 Lm; 5,000K)						1L5W	
PHX22-74-57K - 74W (9982 Lm; 5,700K)						1L6B	
PHX22-102-3K - 102W (12615 Lm; 3,000K)						1L6W	
PHX22-102-35K - 102W (12701 Lm; 3,500K)						1L7B	
PHX22-102-4K - 102W (12787 Lm; 4,000K)						1L7W	
PHX22-102-45K - 102W (12873 Lm; 4,500K)						1SB	
PHX22-102-5K - 102W (12959 Lm; 5,000K)						1SW	
PHX22-102-57K - 102W (13045 Lm; 5,700K)						6FW	
PHX22-145-4K - 145W (17849 Lm; 4,000K)						6L5B	
PHX22-145-5K - 145W (18333 Lm; 5,000K)						6L5W	
PHX22-230-4K - 230W (28333 Lm; 4,000K)						6L6B	
PHX22-230-5K - 230W (28812 Lm; 5,000K)						6L6W	
						6L7B	
						6L7W	
						6LBWG	
						6SB	
						6SW	

Indicates stock options

\* 3/4" threaded hub is standard. Louvers Intl does not provide pendant.

Sample Part Number: PHX22-74-5K-U-FPC-W-D-P-6LBWG-OCC

### Cord & Plug Descriptions:

- 15B – 10' Black 5-15 Straight Blade Plug
- 15W – 10' White 5-15 Straight Blade Plug
- 65B – 6' Black 5-15 Straight Blade Plug
- 65W – 6' White 5-15 Straight Blade Plug
- 1L5B – 10' L5-15 Black 120V Twist Lock
- 1L5W – 10' L5-15 White 120V Twist Lock
- 1L6B – 10' L6-15 Black 250V Twist Lock
- 1L6W – 10' L6-15 White 250V Twist Lock
- 1L7B – 10' L7-15 Black 277V Twist Lock
- 1L7W – 10' L7-15 White 277V Twist Lock
- 1SB – 10' Standard Black 120/277V (No Plug)
- 1SW – 10' Standard White 120/277V (No Plug)
- 6FW – 6' Flexible Whip
- 6L5B – 6' L5-15 Black 120V Twist Lock
- 6L5W – 6' L5-15 White 120V Twist Lock
- 6L6B – 6' L6-15 Black 250V Twist Lock
- 6L6W – 6' L6-15 White 250V Twist Lock
- 6L7B – 6' L7-15 Black 277V Twist Lock
- 6L7W – 6' L7-15 White 277V Twist Lock
- 6LBWG – 6' Black, White and Green Leads (Standard with No Plug)
- 6SB – 6' Standard Black 120/277V (No Plug)
- 6SW – 6' Standard White 120/277V (No Plug)

### Lens Descriptions:

- FPC – White Polycarbonate

### Options Descriptions:

- OCC – Occupancy Sensor
- BLD – Bi-Level Dimming
- PHO – Photocell